

| | |
|-----------|-------|
| PROJECT | _____ |
| TYPE | _____ |
| SPECIFIER | _____ |
| QUANTITY | _____ |
| DATE | _____ |

BIONIQ ROUND ADJUSTABLE RECESSED

A35233-

base number Color _____ Finishes _____
 Temperature (Diamond)

- To build a product code in our configurator select the specify button on the base model # product page
- To build a manual product code on this datasheet choose from the options listed below in blue font and add the suffix to the base model #

GENERAL

Series: Bioniq
 Subseries: Bioniq Round Adjustable
 Brand: Prolicht
 Division: Architectural
 Mounting Type: Recessed
 Mounting Location: Ceiling
 Subcategory: Downlight

PHYSICAL

Shape: Round
 Diameter (mm): 139
 Diameter (in): 5 1/2
 Height (mm): 137
 Height (in): 5 3/8
 Ceiling Thickness (mm): 10 / 12.5 / 15
 Ceiling Thickness (in): 3/8 or 1/2 or 9/16
 Min. Recessing Depth (mm): 150
 Min. Recessing Depth (in): 5 7/8
 Light Distribution: Adjustable / Downlight
 Weight (kg): 0.805
 Weight (lbs): 1.77
 Fixture Finish: SSR / BKV / CWI / CRY / HAB / UFT / ITA / RUA / FTG / MYG / LOD / PUS / FRO / FUP / KIA / POP / BLS / SPG / MEY / GOH / GUM / CHC / COM / ABZ / JAG / OBR / MOS / ROR
 Fixture Material: Aluminum Die Cast
 Cut-out Measurements: 130mm / 5 1/8"

ELECTRICAL

Lamp Type: LED (Zhaga Standard)
 Input Wattage (W): 13.2 / 16.5
 Total Output Wattage (W): 12 / 14
 Dimming: Tri-Mode (Non-Dimming and Phase Dimming (120Vac only) and 0-10V Dimming)
 Driver Included: No
 Driver Location: Recessed Housing
 Driver Type: Constant Current - Universal
 Driver Class: Class 2
 Housing: See components
 Input Voltage (V): 120 - 277
 Constant Current (MA): 350

LED

Number of LEDs: 1
 Color Temperature (°K): 2700 / 3000 / 3500 / 4000
 Max. Delivered Lumen (lm): 870 / 970 / 1039 / 1060
 Nominal Lumen (lm): 960 / 1070 / 1156 / 1180
 CRI: >90 CRI
 Efficiency (%): 0.905
 Lamp Life (hrs): 50000

OPTICAL

Reflector°: 10
 Optic°: Lens Pack - No Lens
 Adjustability: Rotational 355°; Tilt 30°

RATINGS AND CERTIFICATIONS

Certified By: CSA Certified to UL and CSA Standards
 IP rating: IP20



BIONIQ ROUND ADJUSTABLE RECESSED

A35233-

PROJECT

TYPE

SPECIFIER

QUANTITY

DATE



| | |
|-----------|-------|
| PROJECT | _____ |
| TYPE | _____ |
| SPECIFIER | _____ |
| QUANTITY | _____ |
| DATE | _____ |

BIONIQ ROUND ADJUSTABLE RECESSED

A35245- _____ - _____

base number Color _____ Finishes _____
 Temperature (Diamond)

- To build a product code in our configurator select the specify button on the base model # product page
- To build a manual product code on this datasheet choose from the options listed below in blue font and add the suffix to the base model #

GENERAL

Series: Bioniq
 Subseries: Bioniq Round Adjustable
 Brand: Prolicht
 Division: Architectural
 Mounting Type: Recessed
 Mounting Location: Ceiling
 Subcategory: Downlight

PHYSICAL

Shape: Round
 Diameter (mm): 139
 Diameter (in): 5 1/2
 Height (mm): 137
 Height (in): 5 3/8
 Ceiling Thickness (mm): 10 / 12.5 / 15
 Ceiling Thickness (in): 3/8 or 1/2 or 9/16
 Min. Recessing Depth (mm): 150
 Min. Recessing Depth (in): 5 7/8
 Light Distribution: Adjustable / Downlight
 Weight (kg): 0.849
 Weight (lbs): 1.87
 Fixture Finish: SSR / BKV / CWI / CRY / HAB / UFT / ITA / RUA / FTG / MYG / LOD / PUS / FRO / FUP / KIA / POP / BLS / SPG / MEY / GOH / GUM / CHC / COM / ABZ / JAG / OBR / MOS / ROR
 Fixture Material: Aluminum Die Cast
 Cut-out Measurements: 130mm / 5 1/8"

ELECTRICAL

Lamp Type: LED (Zhaga Standard)
 Input Wattage (W): 13.2 / 16.5
 Total Output Wattage (W): 12 / 14
 Dimming: Tri-Mode (Non-Dimming and Phase Dimming (120Vac only) and 0-10V Dimming)
 Driver Included: No
 Driver Location: Recessed Housing
 Driver Type: Constant Current - Universal
 Driver Class: Class 2
 Housing: See components
 Input Voltage (V): 120 - 277
 Constant Current (MA): 350

LED

Number of LEDs: 1
 Color Temperature (°K): 2700 / 3000 / 3500 / 4000
 Max. Delivered Lumen (lm): 810 / 900 / 970 / 990
 Nominal Lumen (lm): 960 / 1070 / 1156 / 1180
 CRI: >90 CRI
 Efficiency (%): 0.905
 Lamp Life (hrs): 50000







OPTICAL

Reflector°: 10
 Adjustability: Rotational 355°; Tilt 30°

RATINGS AND CERTIFICATIONS

Certified By: Certified for North American Standards
 IP rating: IP54



130mm 5 1/8" 150mm 5 7/8" 10 | 15mm 3/8" 9/16" 30° 355°

A

BIONIQ ROUND ADJUSTABLE RECESSED

A35245-

PROJECT

TYPE

SPECIFIER

QUANTITY

DATE



| | |
|-----------|-------|
| PROJECT | _____ |
| TYPE | _____ |
| SPECIFIER | _____ |
| QUANTITY | _____ |
| DATE | _____ |

BIONIQ ROUND SEMI ADJUSTABLE RECESSED

A35299- _____

base number Color _____ Finishes _____
 Temperature (Diamond)

- To build a product code in our configurator select the specify button on the base model # product page
- To build a manual product code on this datasheet choose from the options listed below in blue font and add the suffix to the base model #

GENERAL

Series: Bioniq
 Subseries: Bioniq Round Semi Adjustable
 Brand: Prolicht
 Division: Architectural
 Mounting Type: Recessed
 Mounting Location: Ceiling
 Subcategory: Downlight

PHYSICAL

Shape: Round
 Diameter (mm): 139
 Diameter (in): 5 1/2
 Height (mm): 137
 Height (in): 5 3/8
 Ceiling Thickness (mm): 10 / 12.5 / 15
 Ceiling Thickness (in): 3/8 or 1/2 or 9/16
 Min. Recessing Depth (mm): 150
 Min. Recessing Depth (in): 5 7/8
 Light Distribution: Adjustable / Downlight
 Weight (kg): 0.814
 Weight (lbs): 1.79
 Fixture Finish: SSR / BKV / CWI / CRY / HAB / UFT / ITA / RUA / FTG / MYG / LOD / PUS / FRO / FUP / KIA / POP / BLS / SPG / MEY / GOH / GUM / CHC / COM / ABZ / JAG / OBR / MOS / ROR
 Fixture Material: Aluminum Die Cast
 Cut-out Measurements: 130mm / 5 1/8"



ELECTRICAL

Lamp Type: LED (Zhaga Standard)
 Input Wattage (W): 13.2 / 16.5
 Total Output Wattage (W): 12 / 14
 Dimming: Tri-Mode (Non-Dimming and Phase Dimming (120Vac only) and 0-10V Dimming)
 Driver Included: No
 Driver Location: Recessed Housing
 Driver Type: Constant Current - Universal
 Driver Class: Class 2
 Housing: See components
 Input Voltage (V): 120 - 277
 Constant Current (MA): 350

LED

Number of LEDs: 1
 Color Temperature (°K): 2700 / 3000 / 3500 / 4000
 Max. Delivered Lumen (lm): 870 / 970 / 1039 / 1060
 Nominal Lumen (lm): 960 / 1070 / 1156 / 1180
 CRI: >90 CRI
 Efficiency (%): 90.5
 Lamp Life (hrs): 50000

OPTICAL

Reflector°: 10
 Adjustability: Rotational 355°; Tilt 10°

RATINGS AND CERTIFICATIONS

Certified By: Certified for North American Standards
 IP rating: IP20



BIONIQ ROUND SEMI ADJUSTABLE RECESSED

A35299-

PROJECT

TYPE

SPECIFIER

QUANTITY

DATE



| | |
|-----------|-------|
| PROJECT | _____ |
| TYPE | _____ |
| SPECIFIER | _____ |
| QUANTITY | _____ |
| DATE | _____ |

BIONIQ ROUND SEMI ADJUSTABLE RECESSED

A35311-

base number Color Finishes
 Temperature (Diamond)

- To build a product code in our configurator select the specify button on the base model # product page
- To build a manual product code on this datasheet choose from the options listed below in blue font and add the suffix to the base model #

GENERAL

Series: Bioniq
 Subseries: Bioniq Round Semi Adjustable
 Brand: Prolicht
 Division: Architectural
 Mounting Type: Recessed
 Mounting Location: Ceiling
 Subcategory: Downlight

PHYSICAL

Shape: Round
 Diameter (mm): 139
 Diameter (in): 5 1/2
 Height (mm): 137
 Height (in): 5 3/8
 Ceiling Thickness (mm): 10 / 12.5 / 15
 Ceiling Thickness (in): 3/8 or 1/2 or 9/16
 Min. Recessing Depth (mm): 150
 Min. Recessing Depth (in): 5 7/8
 Light Distribution: Adjustable / Downlight
 Weight (kg): 0.851
 Weight (lbs): 1.88
 Fixture Finish: SSR / BKV / CWI / CRY / HAB / UFT / ITA / RUA / FTG / MYG / LOD / PUS / FRO / FUP / KIA / POP / BLS / SPG / MEY / GOH / GUM / CHC / COM / ABZ / JAG / OBR / MOS / ROR
 Fixture Material: Aluminum Die Cast
 Cut-out Measurements: 130mm / 5 1/8"



ELECTRICAL

Lamp Type: LED (Zhaga Standard)
 Input Wattage (W): 13.2 / 16.5
 Total Output Wattage (W): 12 / 14
 Dimming: Tri-Mode (Non-Dimming and Phase Dimming (120Vac only) and 0-10V Dimming)
 Driver Included: No
 Driver Location: Recessed Housing
 Driver Type: Constant Current - Universal
 Driver Class: Class 2
 Housing: See components
 Input Voltage (V): 120 - 277
 Constant Current (MA): 350

LED

Number of LEDs: 1
 Color Temperature (°K): 2700 / 3000 / 3500 / 4000
 Max. Delivered Lumen (lm): 810 / 900 / 970 / 990
 Nominal Lumen (lm): 960 / 1070 / 1156 / 1180
 CRI: >90 CRI
 Efficiency (%): 0.905
 Lamp Life (hrs): 50000

OPTICAL

Reflector°: 10
 Adjustability: Rotational 355°; Tilt 10°

RATINGS AND CERTIFICATIONS

Certified By: Certified for North American Standards
 IP rating: IP54



BIONIQ ROUND SEMI ADJUSTABLE RECESSED

A35311-

PROJECT

TYPE

SPECIFIER

QUANTITY

DATE



BIONIQ SQUARE ADJUSTABLE COMFORT RECESSED

A35365- _____
 base number Color _____ Finishes _____ Finishes _____ Finishes _____
 Temperature (Diamond) (Triangle) (Circle)

- To build a product code in our configurator select the specify button on the base model # product page
- To build a manual product code on this datasheet choose from the options listed below in blue font and add the suffix to the base model #

GENERAL

Series: Bioniq
 Subseries: Bioniq Square Adjustable Comfort
 Brand: Prolight
 Division: Architectural
 Mounting Type: Recessed
 Mounting Location: Ceiling
 Subcategory: Downlight

PHYSICAL

Shape: Square
 Length (mm): 119
 Length (in): 4 11/16
 Width (mm): 119
 Width (in): 4 11/16
 Depth (mm): 132
 Depth (in): 5 3/16
 Ceiling Thickness (mm): 10 / 12.5 / 15
 Ceiling Thickness (in): 3/8 or 1/2 or 9/16
 Min. Recessing Depth (mm): 150
 Min. Recessing Depth (in): 5 7/8
 Light Distribution: Adjustable / Downlight
 Weight (kg): 0.608
 Weight (lbs): 1.34
 Fixture Finish: SSR / BKV / CWI / CRY / HAB / UFT / ITA / RUA / FTG / MYG / LOD / PUS / FRO / FUP / KIA / POP / BLS / SPG / MEY / GOH / GUM / CHC / COM / ABZ / JAG / OBR / MOS / ROR
 Fixture Material: Aluminum Die Cast
 Cut-out Measurements: 114mm / 4 1/2" x 114mm / 4 1/2"

ELECTRICAL

Lamp Type: LED (Zhaga Standard)
 Input Wattage (W): 13.2 / 16.5
 Total Output Wattage (W): 12 / 14
 Dimming: Tri-Mode (Non-Dimming and Phase Dimming (120Vac only) and 0-10V Dimming)
 Driver Included: No
 Driver Location: Recessed Housing
 Driver Type: Constant Current - Universal
 Driver Class: Class 2
 Housing: See components
 Input Voltage (V): 120 - 277
 Constant Current (MA): 350

LED

Number of LEDs: 1
 Color Temperature (°K): 2700 / 3000 / 3500 / 4000
 Max. Delivered Lumen (lm): 850 / 950 / 1029 / 1050
 Nominal Lumen (lm): 960 / 1070 / 1156 / 1180
 CRI: >90 CRI
 Lamp Life (hrs): 50000

OPTICAL

Reflector°: 10
 Adjustability: Rotational 355°; Tilt 30°

RATINGS AND CERTIFICATIONS

Certified By: Certified for North American Standards
 Zaneen Lighting Inc. © 2024, T 1800-388-3382, F 416-247-9319, www.zaneen.com

Available for International specifications by adding 'INT' at the end of the existing Model #. For assistance on 'custom' specifications, contact zteam@zaneen.com. In a constant effort to supply the best product, we reserve the right to change specifications or materials without notice. The most recent specification sheets are found at zaneen.com

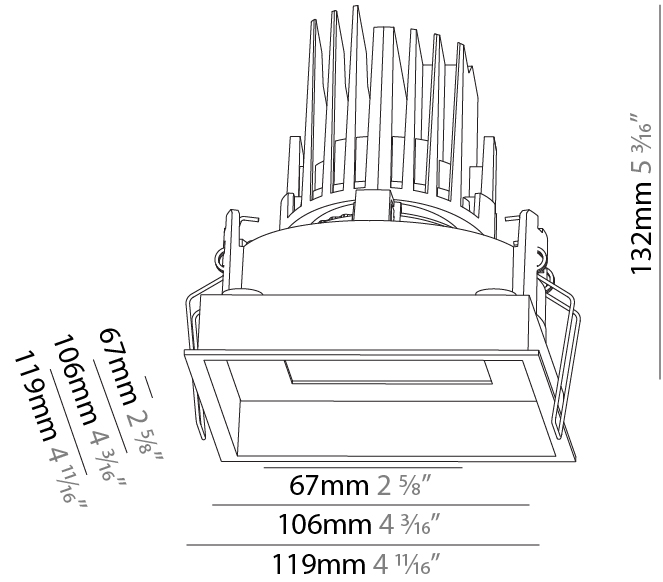

BIONIQ SQUARE ADJUSTABLE COMFORT RECESSED

A35365-

PROJECT _____

TYPE _____

SPECIFIER _____

QUANTITY _____

DATE _____



A

BIONIQ ROUND DEEP RECESSED

A35544- _____ - _____

base number Finishes (Diamond) Reflector Options

- To build a product code in our configurator select the specify button on the base model # product page
- To build a manual product code on this datasheet choose from the options listed below in blue font and add the suffix to the base model #

GENERAL

Series: Bioniq
 Subseries: Bioniq Round Deep
 Brand: Prolicht
 Division: Architectural
 Mounting Type: Recessed
 Mounting Location: Ceiling
 Subcategory: Downlight

PHYSICAL

Shape: Round
 Diameter (mm): 107
 Diameter (in): 4 3/16
 Height (mm): 130
 Height (in): 5 1/8
 Ceiling Thickness (mm): 10 / 12.5 / 15
 Ceiling Thickness (in): 3/8 or 1/2 or 9/16
 Min. Recessing Depth (mm): 150
 Min. Recessing Depth (in): 5 7/8
 Light Distribution: Downlight
 Weight (kg): 0.506
 Weight (lbs): 1.12
 Fixture Finish: SSR / BKV / CWI / CRY / HAB / UFT / ITA / RUA / FTG / MYG / LOD / PUS / FRO / FUP / KIA / POP / BLS / SPG / MEY / GOH / GUM / CHC / COM / ABZ / JAG / OBR / MOS / ROR
 Fixture Material: Aluminum Die Cast
 Cut-out Measurements: 98mm / 3 7/8"

ELECTRICAL

Lamp Type: LED (Zhaga Standard)
 Total Output Wattage (W): 15
 Dimming: Dali Dimming
 Driver Included: No
 Driver Location: Recessed Housing
 Driver Type: Constant Current - 120Vac
 Housing: See components
 Input Voltage (V): 120
 Constant Current (MA): 350

LED

Number of LEDs: 1
 Color Temperature (°K): Warm Dim
 Max. Delivered Lumen (lm): 760
 Nominal Lumen (lm): 1140
 CRI: >90 CRI

OPTICAL

Reflector: 20 / 40 / 60

RATINGS AND CERTIFICATIONS

Certified By: Certified for North American Standards
 IP rating: IP20

| | |
|-----------|-------|
| PROJECT | _____ |
| TYPE | _____ |
| SPECIFIER | _____ |
| QUANTITY | _____ |
| DATE | _____ |



BIONIQ ROUND DEEP RECESSED

A35544-

PROJECT _____

TYPE _____

SPECIFIER _____

QUANTITY _____

DATE _____



BIONIQ SQUARE ADJUSTABLE COMFORT RECESSED

A35551- _____
 base number Finishes (Diamond) Finishes (Triangle) Finishes (Circle) Reflector Options

- To build a product code in our configurator select the specify button on the base model # product page
- To build a manual product code on this datasheet choose from the options listed below in blue font and add the suffix to the base model #

GENERAL

Series: Bioniq
 Subseries: Bioniq Square Adjustable Comfort
 Brand: Prolight
 Division: Architectural
 Mounting Type: Recessed
 Mounting Location: Ceiling
 Subcategory: Downlight

PHYSICAL

Shape: Square
 Length (mm): 119
 Length (in): 4 11/16
 Width (mm): 119
 Width (in): 4 11/16
 Depth (mm): 132
 Depth (in): 5 3/16
 Ceiling Thickness (mm): 10 / 12.5 / 15
 Ceiling Thickness (in): 3/8 or 1/2 or 9/16
 Min. Recessing Depth (mm): 150
 Min. Recessing Depth (in): 5 7/8
 Light Distribution: Adjustable / Downlight
 Weight (kg): 0.607
 Weight (lbs): 1.34
 Fixture Finish: SSR / BKV / CWI / CRY / HAB / UFT / ITA / RUA / FTG / MYG / LOD / PUS / FRO / FUP / KIA / POP / BLS / SPG / MEY / GOH / GUM / CHC / COM / ABZ / JAG / OBR / MOS / ROR
 Fixture Material: Aluminum Die Cast
 Cut-out Measurements: 114mm / 4 1/2" x 114mm / 4 1/2"

ELECTRICAL

Lamp Type: LED (Zhaga Standard)
 Total Output Wattage (W): 15
 Dimming: Dali Dimming
 Driver Included: No
 Driver Location: Recessed Housing
 Driver Type: Constant Current - 120Vac
 Housing: See components
 Input Voltage (V): 120
 Constant Current (MA): 350

LED

Number of LEDs: 1
 Color Temperature (°K): Warm Dim
 Max. Delivered Lumen (lm): 760
 Nominal Lumen (lm): 1140
 CRI: >90 CRI
 Lamp Life (hrs): 50000

OPTICAL

Reflector: 20 / 40 / 60
 Adjustability: Rotational 355°; Tilt 30°

RATINGS AND CERTIFICATIONS

Certified By: Certified for North American Standards
 IP rating: IP20



BIONIQ SQUARE ADJUSTABLE COMFORT RECESSED

A35551-

| | |
|-----------|-------|
| PROJECT | _____ |
| TYPE | _____ |
| SPECIFIER | _____ |
| QUANTITY | _____ |
| DATE | _____ |



A

| |
|-----------|
| PROJECT |
| TYPE |
| SPECIFIER |
| QUANTITY |
| DATE |

Fixture Finish



Digital: Not all screens are calibrated the same, and therefore, colors will appear differently between screens.

Physical: When texture is involved, there will be variations in color, character and tone within a product series and between product families.

Gun Metal: No Gun Metal finish is alike. It combines a mixture of transparent and black color particles which ensures a highly individual effect and no luminaire being identical.

Champagne Cream, Copper Mine, Ancient Bronze + Jazz Gold: These finishes have slight fading from specific powder coating production. Each luminaire will slightly vary.



LEGEND

| | | | | | |
|--|---|---|--|---|--|
|  | floor-mounted |  | pivotal |  | special LED (upon request) RGB, RGBW, tunable, gold+, meat+, art+, fashion+ |
|  | wall and ceiling: recessed and surface mounted |  | rotating |  | warm dim / natural dimming LED |
|  | ceiling-mounted and wall-mounted |  | illuminate tilted |  | rechargeable battery powered |
|  | wall-mounted |  | color of suspension cable |  | fixture with natural vivid LED (upon request) |
|  | omni-directional light distribution |  | length of suspension cable |  | color rendering index |
|  | direct light distribution |  | reflector degree selection |  | color temperature |
|  | direct/indirect light distribution |  | super spot |  | lumen (luminous flux) |
|  | indirect light distribution |  | lens |  | efficacy (lumens per watt) |
|  | asymmetric light distribution |  | lens pack |  | Unified Glare Rating (UGR) range from 5-40 |
|  | aura light distribution |  | shine ring |  | marine grade (AISI 316 stainless steel) |
|  | round wall or ceiling cut-out |  | integrated shine ring with diffuser |  | walk on |
|  | square wall or ceiling cut-out |  | free individual colors 01-29 |  | drive on |
|  | the supplied jig specifies the cutout dimensions |  | individual colors: 00 (free of charge), 01-25 (extra charge) |  | Dark Sky Compliance |
|  | minimum distance (meters) lamp - object |  | luminaire part to be colored (F1) |  | Americans with Disabilities Act (less than 4" off the wall located between 27"-84" from floor) |
|  | recessed depth |  | luminaire part to be colored (F2) |  | lamp protected against explosion |
|  | ceiling thickness in mm |  | luminaire part to be colored (F3) |  | blown glass using traditional methods by master glass blower |
|  | ceiling thickness selection |  | luminaire part to be colored (F4) |  | acoustic material |
|  | dimnable DP (phase), DV (0-10V), DD (dali), DS (step-dim) |  | luminaire part to be colored (F5) |  | protection class I, protection insulation |
|  | included or excluded LED driver/transformer/control gear |  | color of 3-circuit adaptor |  | protection class II, protection insulation |
|  | separately switchable |  | indirect diffuser |  | ETL Certified to UL and CSA Standards |
|  | sensor |  | direct diffuser |  | UL Certified to UL and CSA Standards |
|  | remote control |  | ball-proof (upon request) |  | CSA Certified to UL and CSA Standards |
|  | available upon request |  | accessory |  | Certified for North American Standards |

IP RATING

| | |
|---|--|
|  | protected against ingress of solid bodies greater than 12.5mm (finger) |
|  | protected against ingress of solid bodies greater than 2.5mm protected against sprays of water up to 60 degrees from the vertical (rain) |
|  | protected against ingress of solid bodies greater than 1mm (wire) no protection against the ingress of moisture |
|  | protected against ingress of solid bodies greater than 1mm (wire) protected against sprays of water up to 60 degrees from the vertical (rain) |
|  | protected against ingress of solid bodies greater than 1mm (wire) protected against water splashed from all directions |
|  | protected against limited ingress of dust (wet rooms/covered outdoor areas) protected against water splashed from all directions |
|  | protected against ingress of dust protected against jets of water |
|  | protected against ingress of dust protected against powerful jets of water or heavy seas |
|  | protected against ingress of dust protected against immersion of water between 15cm - 1m for 30 minutes |
|  | protected against ingress of dust protected against immersion of water under pressure for long periods |

IK RATING

| | |
|---|---|
|  | protected against 0.14 joules impact (equivalent to 0.25kg mass dropped from 56mm above the surface) |
|  | protected against 0.2 joules impact (equivalent to 0.25kg mass dropped from 80mm above the surface) |
|  | protected against 0.35 joules impact (equivalent to 0.25kg mass dropped from 140mm above the surface) |
|  | protected against 0.5 joules impact (equivalent to 0.25kg mass dropped from 200mm above the surface) |
|  | protected against 0.7 joules impact (equivalent to 0.25kg mass dropped from 280mm above the surface) |
|  | protected against 1 joules impact (equivalent to 0.25kg mass dropped from 400mm above the surface) |
|  | protected against 2 joules impact (equivalent to 0.5kg mass dropped from 400mm above the surface) |
|  | protected against 5 joules impact (equivalent to 1.7kg mass dropped from 300mm above the surface) |
|  | protected against 10 joules impact (equivalent to 5.0kg mass dropped from 200mm above the surface) |
|  | protected against 20 joules impact (equivalent to 5.0kg mass dropped from 400mm above the surface) |